

## On-site Wastewater Management Training Course

### Passive Dosing Systems

#### Siphons and Flouts, Low Pressure Effluent Distribution Systems

Centre for Environmental Training cet

### Siphons

- Transform low or variable flows into regular doses
- Suitable for pressurising manifolds and drainfields
- Have no moving parts
- Require no electricity
- Technology over 100 years old
- Require understanding to ensure appropriate use and operation

Centre for Environmental Training cet

### Various Siphons Available

- Stafford siphon
- Flowking
- ecoteam Surgeflow
- Ubi Aqua by ecoteam
- Orenco

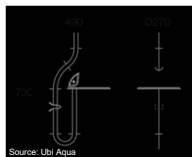

Centre for Environmental Training cet

### Dosing Siphon Anatomy

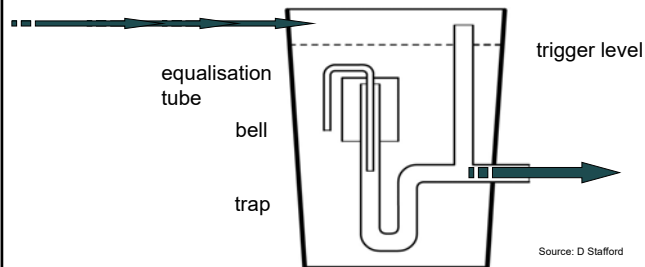

Centre for Environmental Training cet

### Siphon Cycle

trap primed

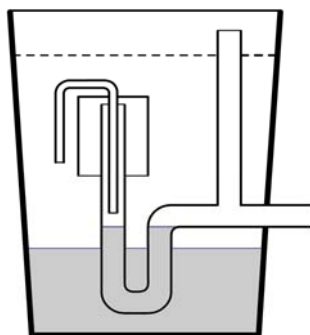

Centre for Environmental Training cet

start and end of cycle

Vented to atmosphere

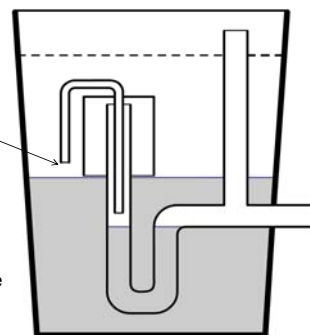

Centre for Environmental Training cet

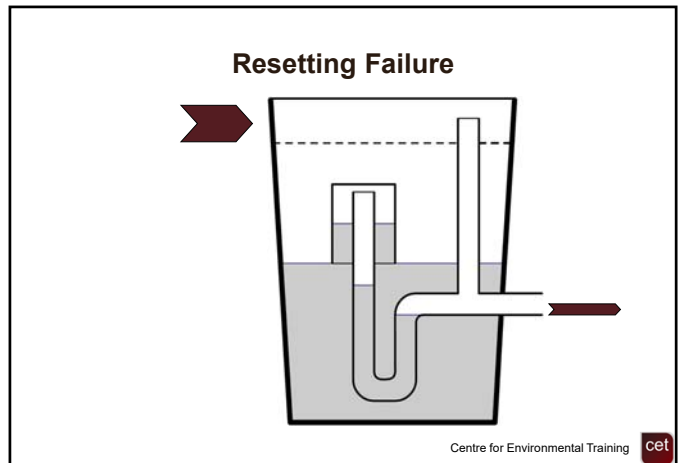
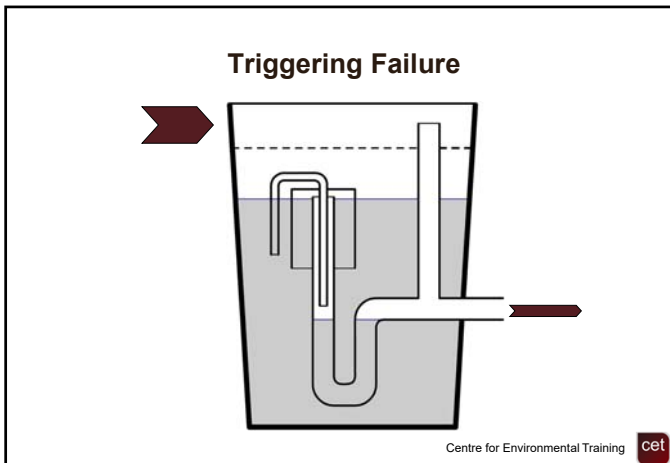
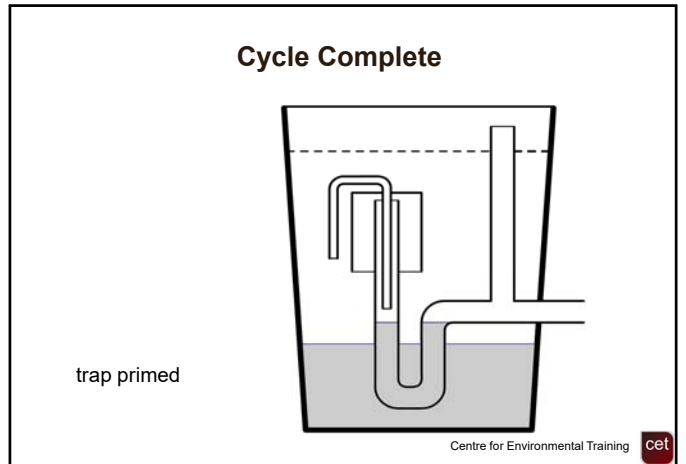
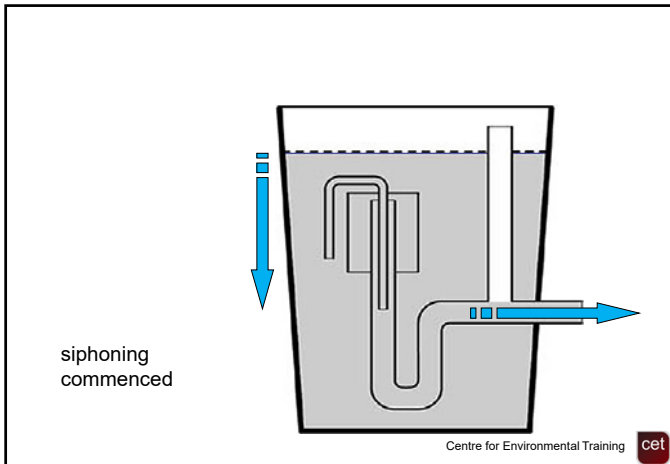
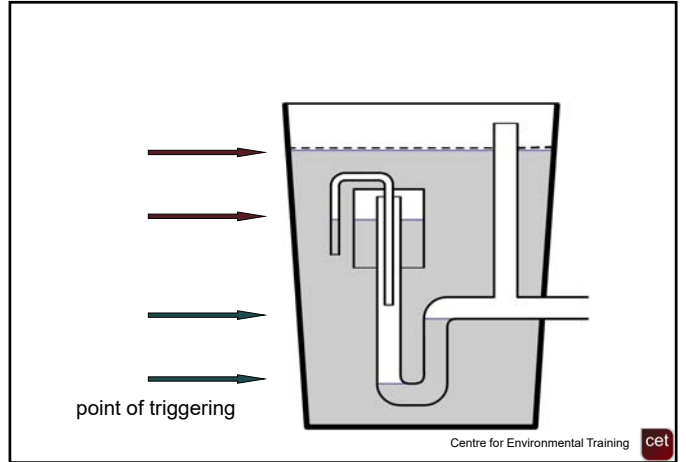
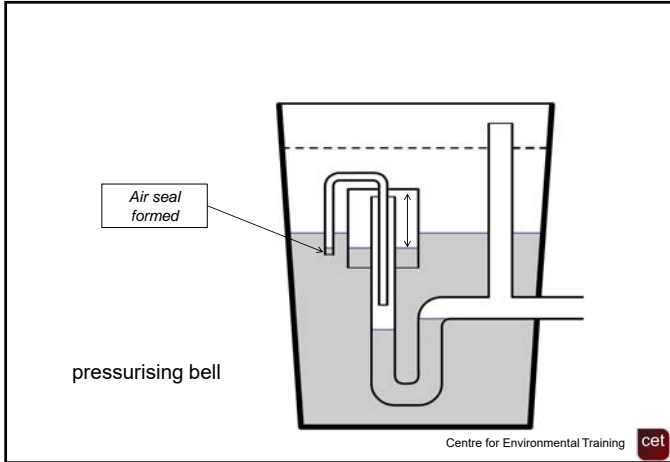

## Siphon Optimisation

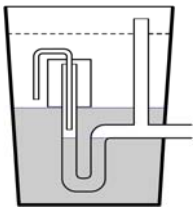

- An outlet filter must be fitted to the septic tank
- Bell:trap volume approximately 3:1
- Bell diameter:trap pipe diameter approximately 3:1
- Deep trap easier to trigger
- Shallow traps need to be driven with high inflow rates
- Balance tube required for reliable resetting
- Calibration of relationship of balance tube ends important

Centre for Environmental Training cet

## Siphon Operation

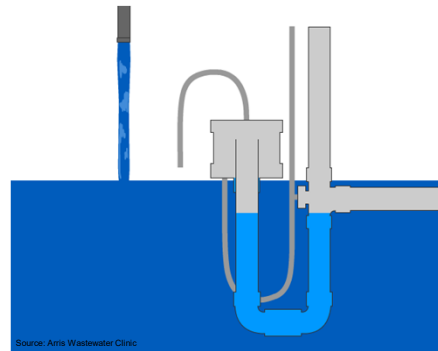

Source: Aris Wastewater Clinic

Centre for Environmental Training cet

## Stafford Siphon Developed

- Reliably triggers at inflow rates  $<0.2$  L/m
- Reliably resets at inflow rates  $>30$  L/m



## Use

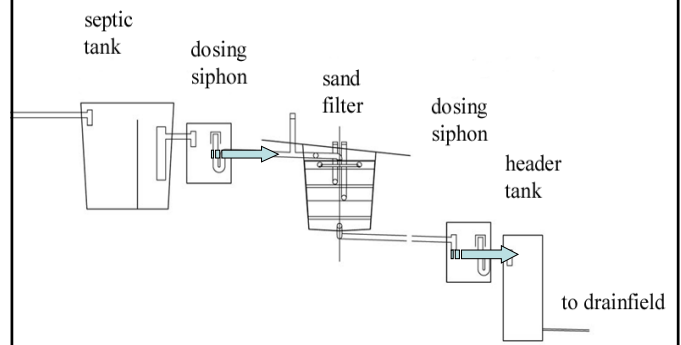

## Applications



- Domestic waste water treatment system, Martinsville, NSW
- One of two dosing siphons in the system

Centre for Environmental Training cet

## Applications



- Cheese making waste treatment, Nimbin, NSW
- Doses a drainfield manifold with limited fall



## Applications



Greywater septic tank to dosing chamber, near Nimbin, NSW

Centre for Environmental Training cet

## Applications



Testing squirt height and uniformity, near Nimbin

Centre for Environmental Training cet

## Flout

- Single flout
- Double flout
- Low drawdown possible with larger dose volume



- <http://www.flout.net/rissyplastics2/>
- <http://control.visionscape.com.au/page29091/Sales---Flout.aspx>

Centre for Environmental Training cet

## Flout

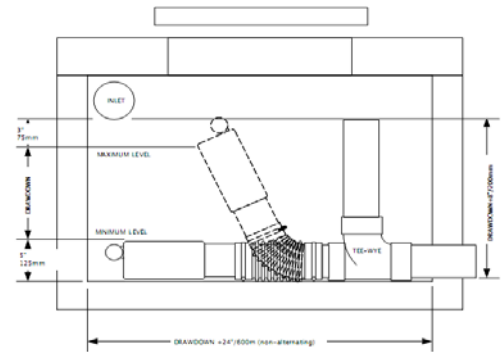

Centre for Environmental Training cet

## Flout dosing a sand filter



Centre for Environmental Training cet

## Flout



## Low Pressure Effluent Distribution (LPED) Systems

### Definitions (AS/NZS1547:2012)

#### LPED Irrigation

- Shallow subsurface irrigation of effluent into topsoil through low pressure effluent distribution (LPED) lines

#### LPED line

- A pressure line perforated with drilled squirt holes and nestled in a distribution line

## LPED Irrigation

- Suitable for both Primary (with outlet filter) and Secondary effluent
- On moderate to flat slopes up to 10-15%
- Distributed into shallow trenches 200mm wide by 200mm deep, excavated in good quality topsoil
- Minimum 250mm topsoil depth required for application onto Category 5 or 6 soils

## LPED Irrigation

- Require dosed flow by siphon or Flout (low pressure) or pump (pressure) - not gravity fed
- Ensures even distribution along entire LPED trench; avoids spot loading of slotted pipe
- Facilitates hydraulic and nutrient uptake by transpiration and seepage
- Use sequencing valve to alternate loading of lines (pump only)

## LPED Irrigation

- Minimum 1,000mm spacing between LPED trenches
- Trenches constructed along the contour on sloping ground (max 15% gradient)
- All LPED systems should incorporate capacity for flushing (as per Figure M3)
- LPED systems require appropriate consideration of hydraulic design

## DIRs for LPED

Soil Category	Soil texture	Structure	Drip and spray irrigation	LPED irrigation
DIR mm/day				
1	Gravel and sand	--	5	Not advised
2	Sandy loam	All	5	4
3	Loam	All	4	3.5
4	Clay loam	All	3.5	3
5	Light clay	All	3	2.5
6	Medium to heavy clay	--	2	Not advised

## LPED Irrigation

- Pressure line 25-40mm PVC with 3-6mm drilled holes at appropriate spacing for even distribution along whole length
- Clean water test to observe even squirt height before covering
- Distribution line Ag-pipe or slotted 100mm PVC

## LPED Irrigation

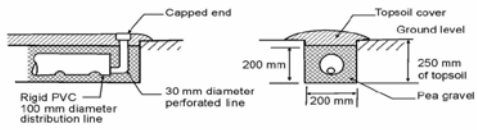
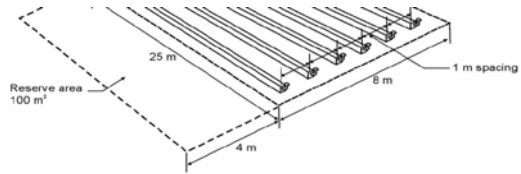

Centre for Environmental Training 

## References

- The Flout Dosing Device. A device for gravity dosing of effluent or stormwater.  
<http://control.visionscape.com.au/page29091/Sales---Flout.aspx>
- Arris Wastewater Clinic automatic dosing siphons  
<https://www.arryswc.com.au/sample-page/automatic-dosing-siphons/>

Centre for Environmental Training 